

Raffia - Natural 33cm Straw Pendant or Lamp Shade



LIGHT SOURCE DATA

- 40W Max B22 BC or E27 ES (required)
- Lamp direction - Indirect
- Lamp shape - Standard
- Dimmable
- Energy class: Not applicable

DIMENSION DATA

- Height 170mm
- Diameter 330mm
- Weight 0.42kg

SPECIFICATION

- Manufacturer warranty for 2 years from date of purchase
- Natural raffia
- IP20
- No
- 240V
- Assembly required? No
- UKCA Marking, Energy Efficient, Energy Saving

CERTIFICATION



CONTACT

www.firstchoicelighting.co.uk

info@firstchoicelighting.co.uk

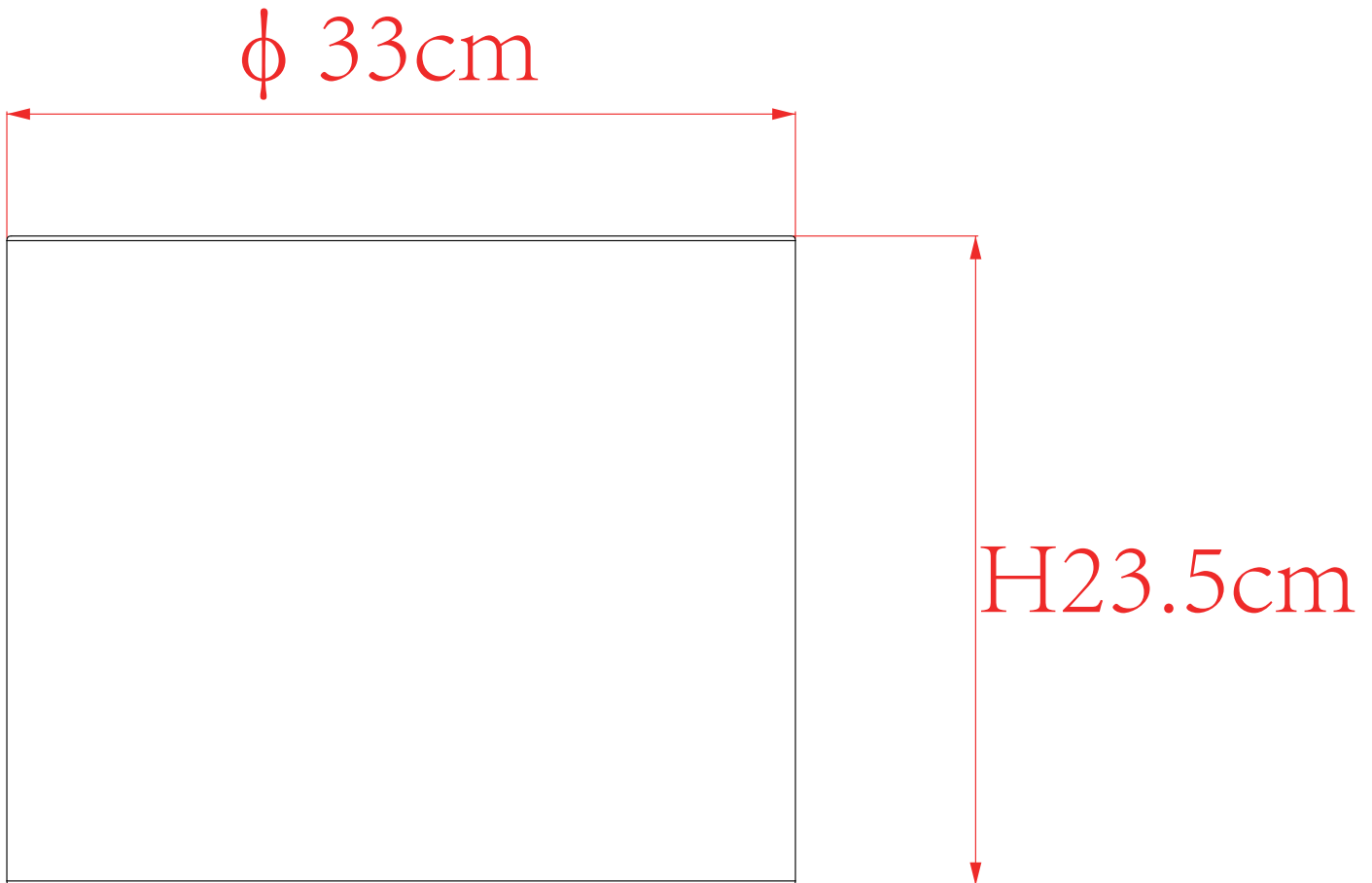

CERTIFICATION



CONTACT

www.firstchoicelighting.co.uk

info@firstchoicelighting.co.uk