

**Elstead - Aegean AG1-POL-NICKEL Wall Light**

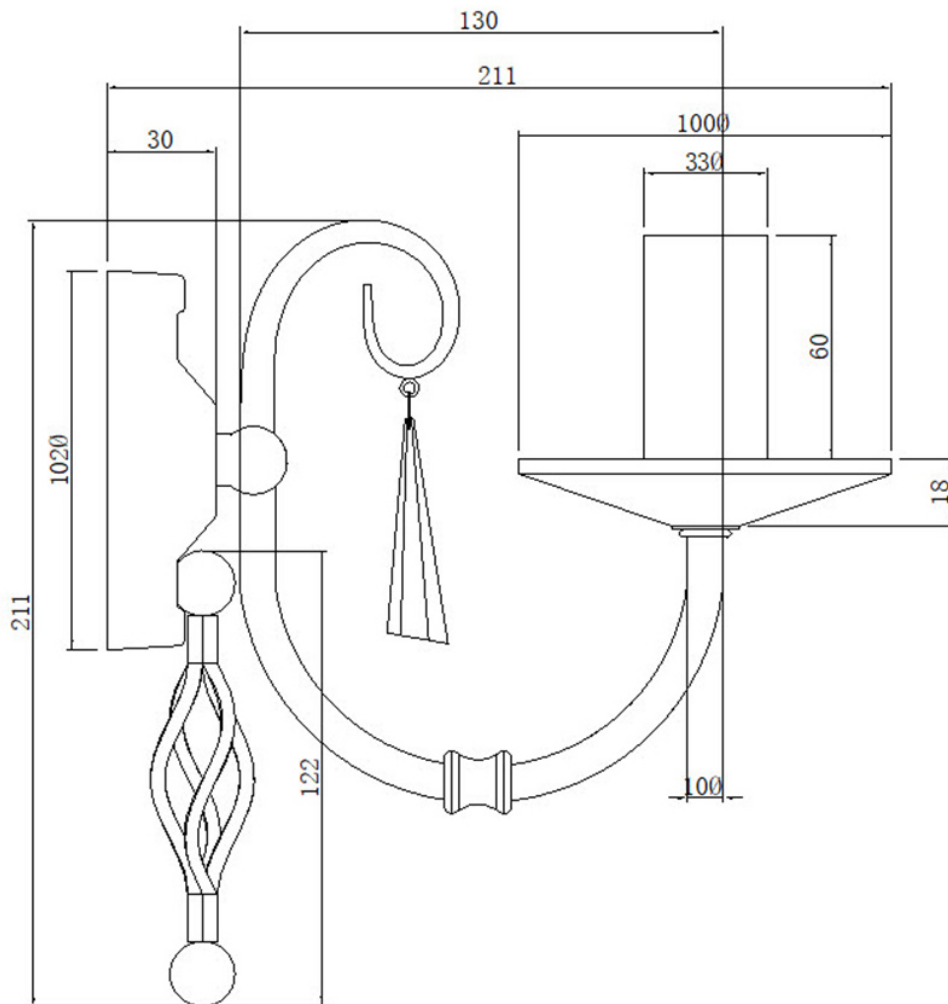

**CONTACT**